

Joy *find. a
feeling*

The Italian bathroom.

Joy



essenza natural/colore bianco opaco – mensolone in ocritec bianco con vasca integrata/essenza natural

*L 210 cm
natural wood/matt white colour – natural wood top with white Ocritec integrated basin
essence Natural/coloris blanc mat – plan de toilette épais en ocritec avec vasque intégrée
blanc/essence Natural*



La boiserie attrezzata, oltre che ad essere un elemento funzionale, arreda e completa l'ambiente bagno.
In addition to being practical, the accessorised wall panelling adds a beautiful finishing touch to the bathroom furniture
Le panneau mural aménagé n'est pas uniquement un élément fonctionnel, mais également un élément décoratif qui complète la salle de bains



L'abbinamento delle diverse essenze alle varie colorazioni disponibili, determinano interpretazioni di stili diversi.

Different styles can be interpreted in various ways by combining the wood finishes available with our colour options.

La combinaison des différentes essences et des divers coloris disponibles permet de multiples interprétations de style.



*colore lucido grigio scuro GL5 –
mensolone in ocritec con vasca integrata
colore fog
L 210 cm*

*gloss grigio scuro GL5 colour - Ocritec top with fog
coloured integrated basin
coloris Grigio scuro GL5 brillant – plan de toilette
épais en ocritec avec vasque intégrée coloris Fog*





Il mensolone lavabo in ocritec è disponibile con singola o doppia vasca integrata ed in 4 colori diversi oltre che in abbinata alle essenze

The Ocritec top is available with a single or double integrated basin and in 4 different colours or paired with wood finishes

Le plan-vasque épais en ocritec existe avec une ou deux vasques intégrées et en 4 différents coloris outre la possibilité de l'associer aux essences

*essenza canapa/colore opaco
tortora – piano in ocritec con vasca
integrata tortora/essenza canapa
L 135 cm*

*canapa wood finish/matt tortora colour –
top in tortora Ocritec/canapa wood with
integrated basin*

*essence Canapa/coloris Tortora mat – plan de
toilette en ocritec avec vasque intégrée coloris
Tortora/essence Canapa*



Una soluzione unica e particolare: il piano top nella stessa finitura del mobile, rovere canapa, ed il colore tortora delle gole riproposto nella vasca lavabo.

A unique and original colour combination consists in the top matching the canapa oak finish of the unit and the tortora colour of the grip recess matching the colour of the washbasin

Une solution unique et particulière : le plan de toilette est réalisé avec la même finition chêne Canapa que le meuble alors que le coloris Tortora des gorges est reproposé pour la vasque

Gli stessi abbinamenti del mobile sono stati ripresi, come coordinato, anche nel piatto doccia.

The shower tray is coordinated with the bathroom furniture finishes

Les mêmes associations de couleur du meuble ont été également reprises dans la douche pour une esthétique assortie





*essenza corda – lavabo in
ocritec Fast
L 35 cm
Corda wood finish – Ocritec Fast
washbasin
Essence Corda – vasque en ocritec Fast*



*Le colonne possono essere
utilizzate anche come pratici vani
attrezzati.
Full-height units can even be used as practical,
accessorised cupboards.
Les colonnes peuvent également être aménagées
et devenir de pratiques éléments de rangement.*



*Un pratico lavamani, realizzato
in ocritec bianco (opaco e
lucido), racchiuso in soli 35.5 cm di
larghezza e 38.5 cm di profondità.
The practical hand basin in white Ocritec
(matt or gloss) takes up just 35.5 cm in width
and 38.5 cm in depth.
Un pratique lave-mains réalisé en ocritec blanc
(mat ou brillant) de seulement 35,5 cm de
large et 38,5 cm de profondeur.*

*rovere cacao/colori opachi ral
8015/8024/8025 - piano in cristallo bronzo
VT30 - LAVABO Pitagora
L 240 cm
cacao oak/matt colours ral 8015/8024/8025 -
glass top VT30 bronzo - Pitagora standing basin
chêne cacao/couleurs matt ral 8015/8024/8025 -
plan de toilette en verre VT30 bronzo - Pitagora
vasque à poser*





Il gioco inclinato delle basi è riproposto anche sugli elementi pensili.
The slant of the base units can also be found on the wall units.
Le jeu incliné des éléments bas est également reproposé pour les éléments hauts.



Il tavolino in lamiera verniciato opaco, trova una facile collocazione ovunque.
The matt lacquered metal table suits any type of setting.
La table d'appoint en tôle laquée mate trouvera facilement une place dans n'importe quelle pièce.



*rovere cacao – piano in tecnoril bianco
opaco – lavabo Avila
L 167 cm
cacao oak - matt white Tecnoril top – Avila vasque à
poser
chêne cacao – plan de toilette en Tecnoril blanc mat –
vasque Avila*





*Interessante ed utile il vano a giorno
posto a lato della composizione.
The open compartment at the side of the composition
adds interest and practicality.
L'élément ouvert sur le côté de la composition est à la
fois intéressant et utile.*



Practical
open
storage





*colore bianco opaco – piano in
tecnoril bianco opaco – lavabo Cus
L 180 cm
matt colour BNO bianco – matt white tecnoril
top – console CUS
couleur mat BNO bianco – plan de toilette en
Tecnoril blanc mat – plan-vasque CUS*



*new
inclined
shapes*

*Il lavabo consolle Cus può essere utilizzato da solo a parete, oppure montato su di una base.
The console Cus can be wall-hung by itself or fitted on top of a base unit.
Le plan-vasque Cus peut être utilisé seul en le fixant au mur ou bien posé sur un élément bas.*

*essenza natural/colore grigio chiaro opaco
- piano cristallo grigio chiaro - lavabo
Jump
L 152 cm
natural wood/matt grigio chiaro colour - grigio chiaro
glass top - Jump washbasin
essence Natural/coloris Grigio chiaro mat - plan de
toilette en verre Grigio chiaro - vasque Jump*





In alternativa al lavabo in appoggio, è possibile utilizzare il nuovo mensolone in ecomalta con vasca integrata.

The new eco-cement top H12 with an integrated basin is a valid alternative to the standing basin.
À la place de la vasque à poser, il est possible de choisir le nouveau plan de toilette H12 en éco-ciment avec vasque moulée.



*rovere cacao/colore lucido ral 5009 –
piano in ocritec con vasca integrata
bianco lucido*

L 120 cm

*cacao oak/glossy ral 5009 colour – gloss white ocritec
top with integrated basin
chêne cacao/couleur RAL 5009 brillant – plan de
toilette avec vasque moulée en Ocritec blanc brillant*





Lo specchio contenitore è disponibile, oltre che nella versione semplice a vasistas, anche arricchito all'interno con luci e fondi a specchi.

As well as in the plain version with a flap door, the mirror cabinet is also available with interior lighting and mirrored bottom panels.

En plus que dans la version simple, l'armoire de toilette à porte relevable existe également avec éclairage intérieur et fond de meuble miroir.



Storage
units
for all
needs



Base inclinata

Inclined base unit. Élément bas incliné. Abgeschrägter Unterschrank. Bajo inclinado.

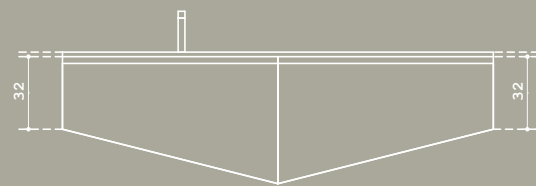
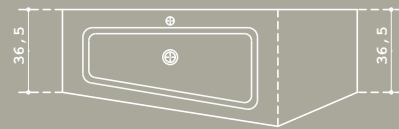
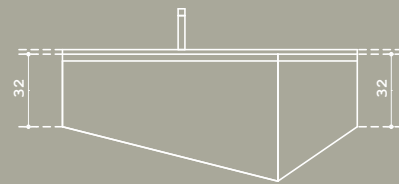
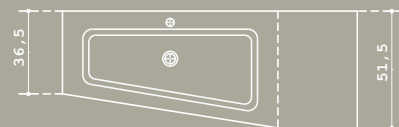
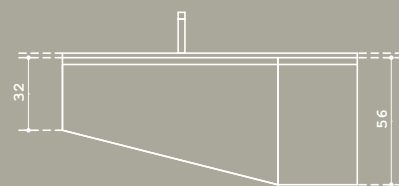
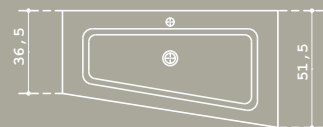
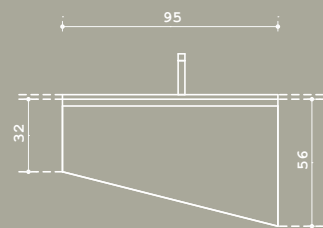

La modularità di Joy si arricchisce di una nuova base inclinata, che consente un'ulteriore versatilità nello sfruttamento degli spazi contenuti. Con la stessa filosofia sono stati pensati i pensili, sempre dal taglio inclinato.

Joy's modularity now extends to include a new inclined base unit that further enhances this model's ability to exploit small spaces. The slanting wall units have been designed around the same basic idea. La modularité de Joy s'enrichit d'un nouveau élément bas incliné qui permet d'exploiter et d'agencer encore mieux les petits espaces. Les éléments hauts, réalisés eux aussi avec une forme inclinée, ont été pensés avec cette même philosophie.

Pensili inclinati

Inclined wall units. Éléments hauts inclinés.

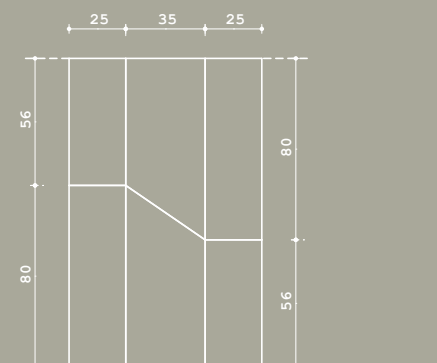
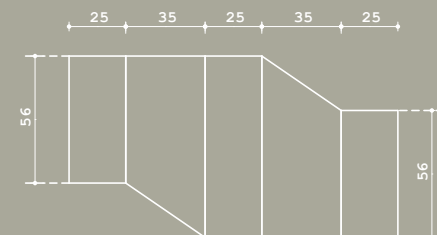
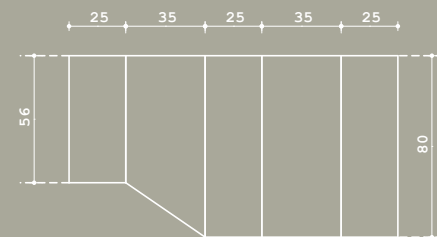

Pensile particolare

Special wall unit. Élément haut particulier. Spezial-Wandschrank. Altos particular.

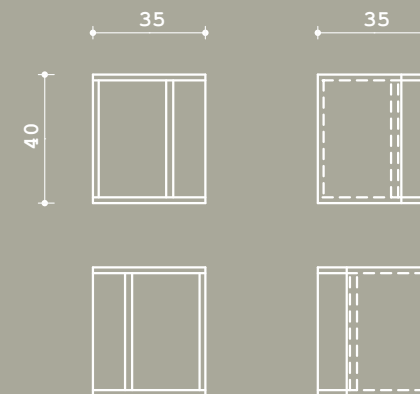

Nuove forme per basi e pensili

New shapes for base and wall units. De nouvelles formes pour les éléments bas et les éléments hauts.

Il pensile particolare, può essere totalmente a giorno o in parte chiuso. È utilizzato sia libero, che in aggregazione agli altri moduli pensile classici.

The special wall unit can be completely open-fronted or partly shut. It can be used by itself or together with the more traditional wall unit modules in the range.

L'élément haut particulier peut être entièrement ouvert ou en partie fermé. Il peut être utilisé seul ou bien associé aux autres modules suspendus classiques.

Pensili liberi e pensili in colonna

Independent and in-column wall units. Éléments hauts individuels et éléments hauts agencés en colonne.

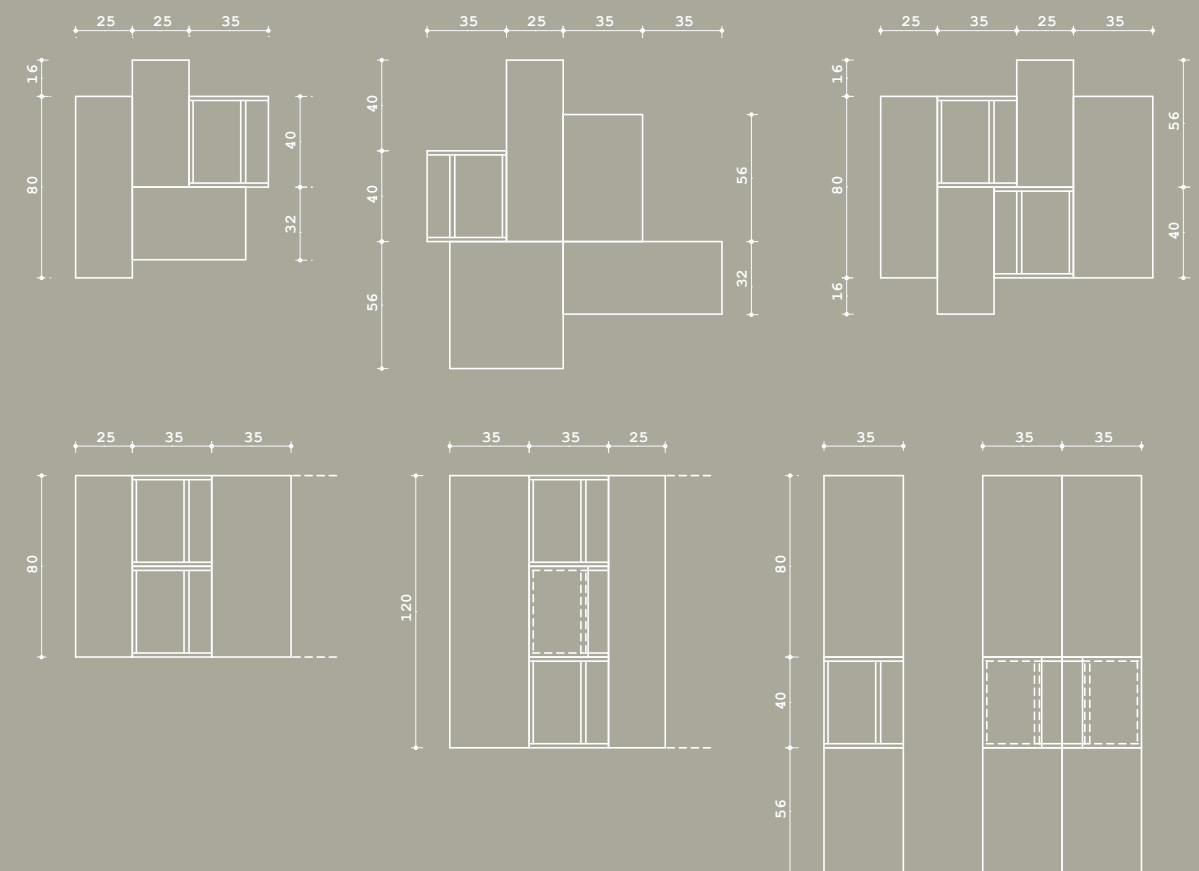



colore lucido tortora leffetto rovere tavolo - piano con vasca integrata in marmo-resina bianco lucido L 190x205 cm
glossy color BL4 tortora/Tavolato oak effect - gloss white hard resin top with integrated basin
couleur brillant BO4 tortora/Effect chêne tavolo - plan de toilette avec vasque moulée en marbre de synthèse blanc brillant



Una soluzione compositiva inconsueta,
che riesce a dare una collocazione
elegante alla lavatrice.

An unusual arrangement that elegantly conceals the
washing machine.

Une solution d'agencement insolite, qui permet
d'installer le lave-linge de façon discrète et élégante.

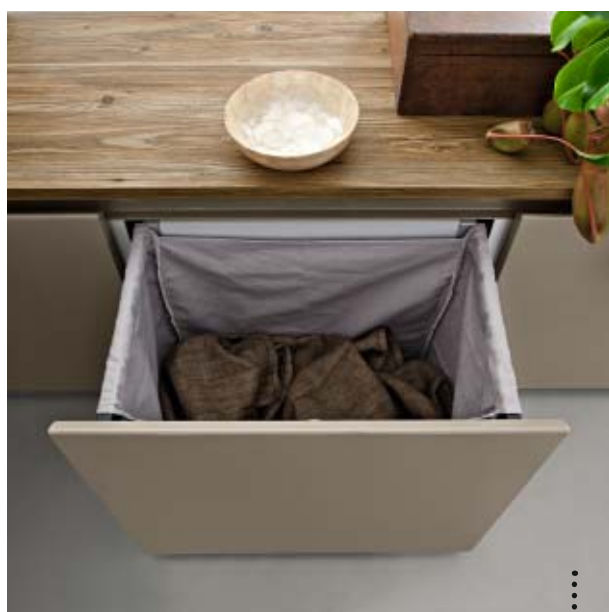

La sacca portabiancheria è disponibile in
più misure.

The laundry bag is available in various sizes.
Le panier à linge est disponible en plusieurs dimensions.





*colore opaco pavone leffetto cemento –
lavabo Prince*

L 200 cm

*matl colour FO5 pavone/Cemento effect – Prince
standing basin*

*couleur mat FO5 pavone/Effet cemento – vasque à
poser Prince*





A sink
at any
height





All'interno delle ante è possibile applicare alcuni dei nuovi elementi contenitori, oltre che le luci di cortesia.

As well as having courtesy lights, some of the new containers can be fitted behind the doors.

En plus que l'éclairage intérieur, il est possible d'installer de nouveaux accessoires à l'intérieur des portes.



Mensoloni
Tops H12-H10-H6. Plans de toilette H12-H10-H6.

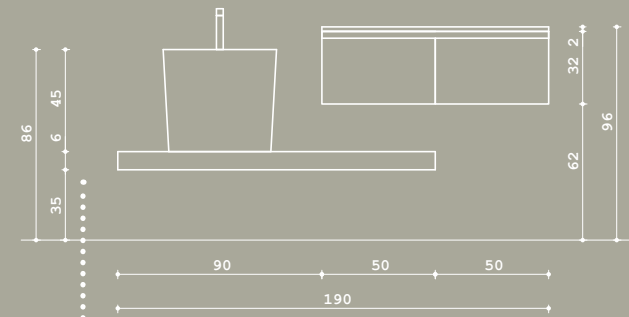
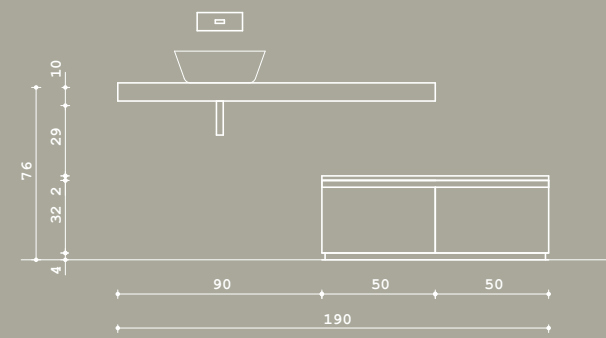
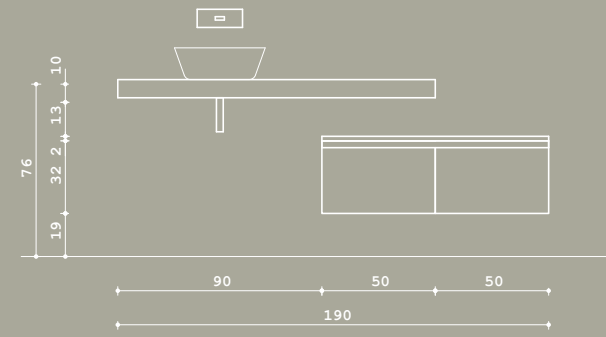

Varie le soluzioni possibili utilizzando i mensoloni, sia a livello compositivo, sia per il tipo di lavabo da poter utilizzare.

The Tops H6 can be used to achieve various types of compositions with an array of different basins.

Différentes solutions possibles pour les plans de toilette H6 tant au niveau de l'agencement que du type de vasque utilisable.

Vasche integrate in ecomalta
prof. 46 e 51,5 cm
Integrated basins in eco-cement. Vasques moulées en éco-ciment.

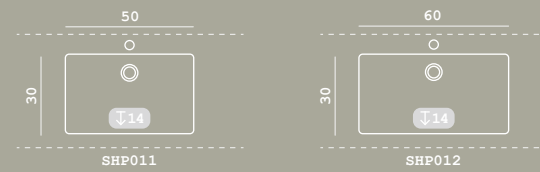

Lavabi in appoggio alti
Tall standing basins. Vasques à poser hautes.

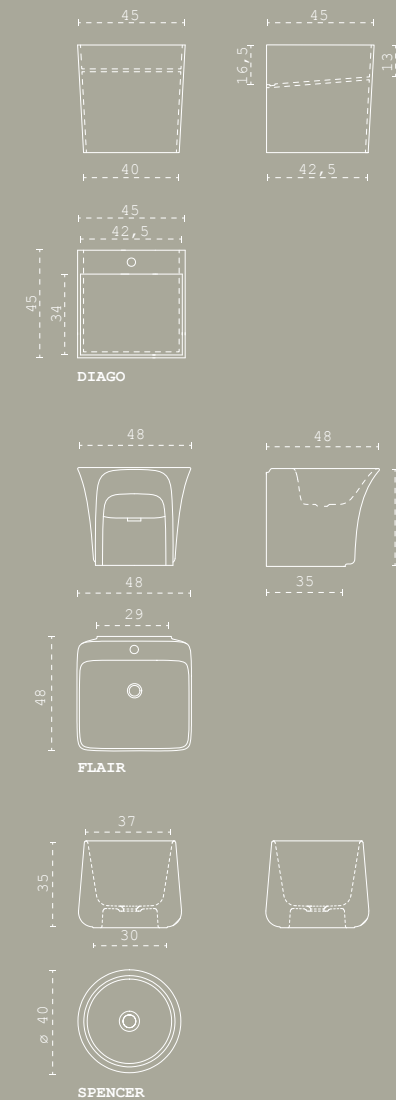

Mensoloni con lavabi integrati o in appoggio

*Tops H12-H10-H6 with integrated or standing basins.
Plans de toilette H12-H10-H6 avec vasque moulée ou à poser.*

Lavabi in appoggio
Standing basins. Vasques à poser. Aufsatzbecken. Lavabos de apoyo.

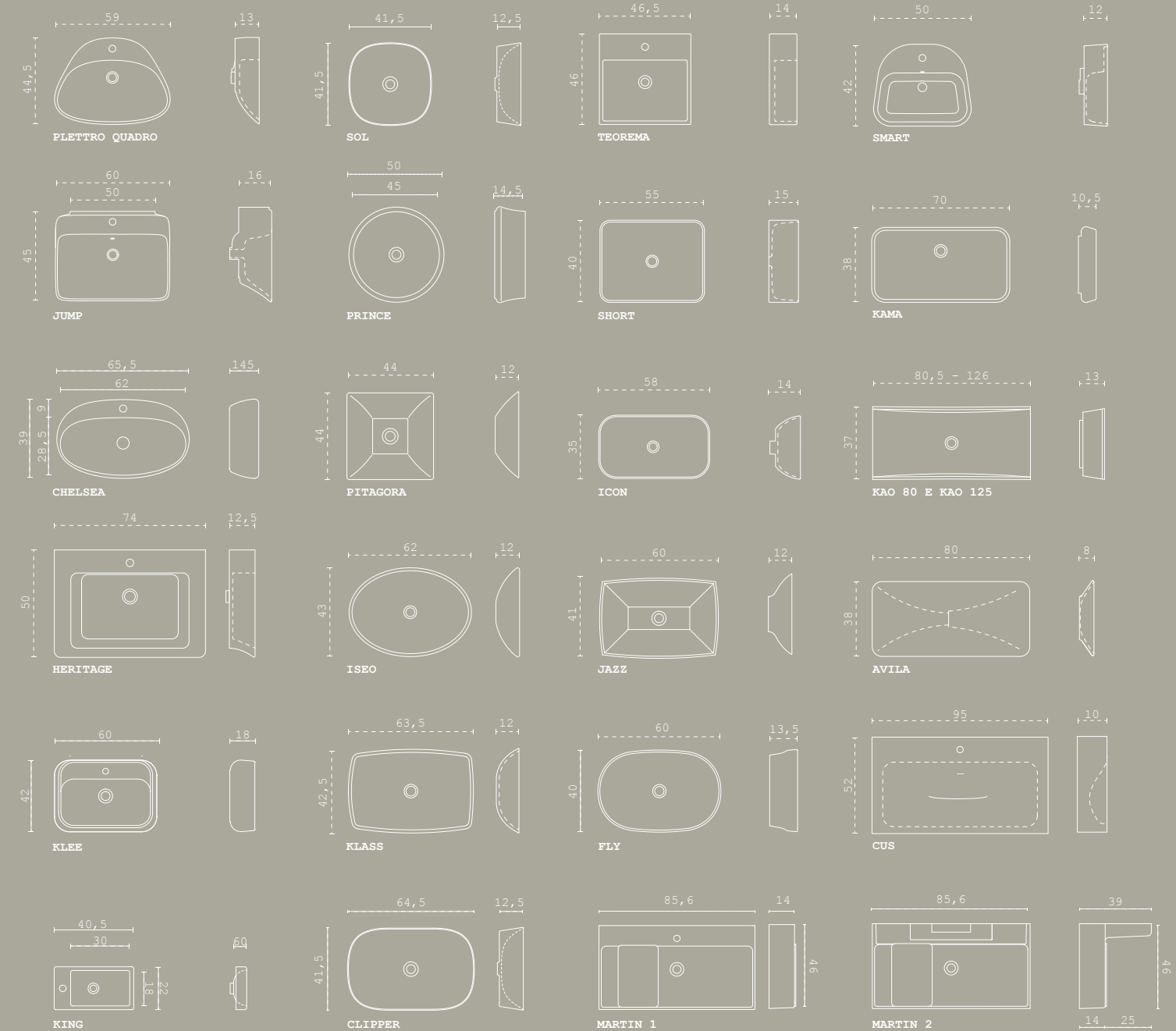

*rovere corda – piano in deimos-
stone ecrù con vasca integrata
L 130 cm*

*corda oak – ecrù Deimos-stone top with
integrated basin*

*chêne Corda – plan de toilette avec vasque
intégrée en deimos-stone ecrù*





New
natural
textures

I piani in deimos-stone con vasca integrata, sono disponibili anche in versione mensolone in tre varianti colore: bianco sale, grigio medio ed ecru.

The Deimos—stone tops with integrated basins are also available in the version with a thick top in three colour options: bianco sale, grigio medio and ecru.

Les plans de toilette en deimos-stone avec vasque intégrée existent également dans la version avec plan de toilette H.6-10 cm décliné en trois coloris au choix : bianco sale, grigio medio et ecru.





La nuova vasca Soft in tecnoril è disponibile in finitura bianco opaco; è prevista sia da centro stanza che a parete, con rubinetteria a parete, bordo vasca o a pavimento. La vasca Soft può essere completata con la struttura perimetrale nello stesso materiale.

The new Soft bath in Tecnoril is available in matt white. It has been designed to be free-standing or back-to-wall and comes with wall-mount, deck or floor-standing tap. The Soft bath can be completed by an edge structure in the same material.

La nouvelle baignoire Soft en Tecnoril est disponible en blanc mat. Elle peut être installée soit au centre d'une pièce soit contre un mur et avoir une robinetterie murale, sur la baignoire ou bien au sol. La baignoire Soft peut être entourée d'un tablier décliné dans le même matériau.

One
object
many
shapes





*bianco lucido/Old age – lavabo Heritage
L.170 cm
glossy color BNL bianco/Old age – Heritage standing
couleur brillant BNL bianco/Old age – vasque à poser
Heritage*





*bianco lucido – piano effetto pietra –
lavabo Pitagora
L. 190 cm
gloss white – stone-effect top – Pitagora washbasin
blanc brillant – plan de toilette aspect Pietra – vasque
Pitagora*

Basi curve
Curved base units. Éléments bas arrondis.

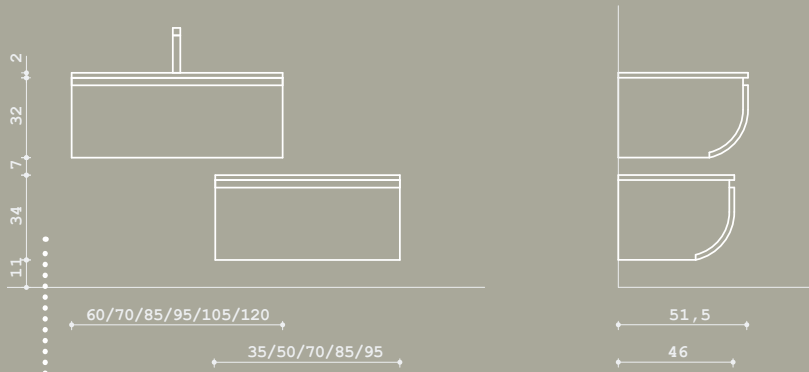
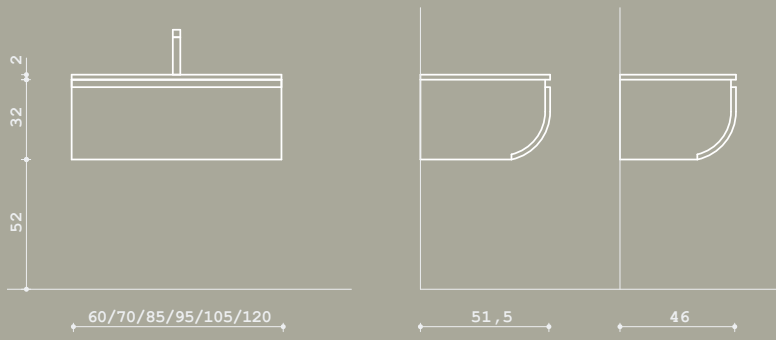
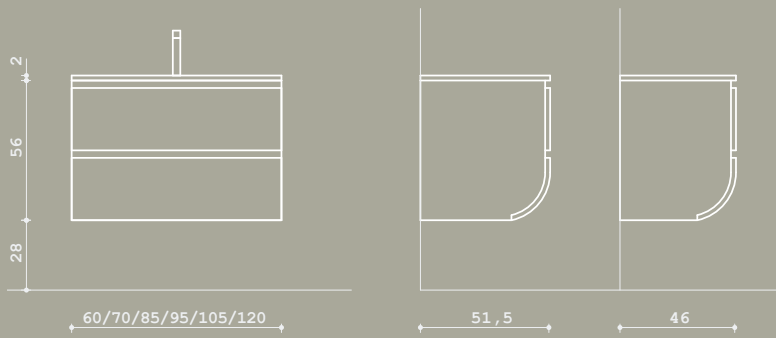

Le basi curve sono disponibili in 2 altezze e in 2 profondità. Possono anche essere mixate fra loro, per soluzioni compositive sempre diverse.

The curved base units are available in 2 heights and 2 depths. They can also be mixed together to achieve many different results.

Les éléments bas arrondis sont disponibles en 2 hauteurs et en 2 profondeurs. Ils peuvent également être combinés entre eux pour obtenir des solutions d'agencement toujours différentes.

Consolle in ceramica per realizzare composizioni monoblocco.

Ceramic console for vanity units.

Plan-vasque en céramique pour réaliser des compositions monoblocs.

Consolle Genius p. 40,0 cm

Genius console D. 40 cm. Plan-vasque Genius p. 40 cm.

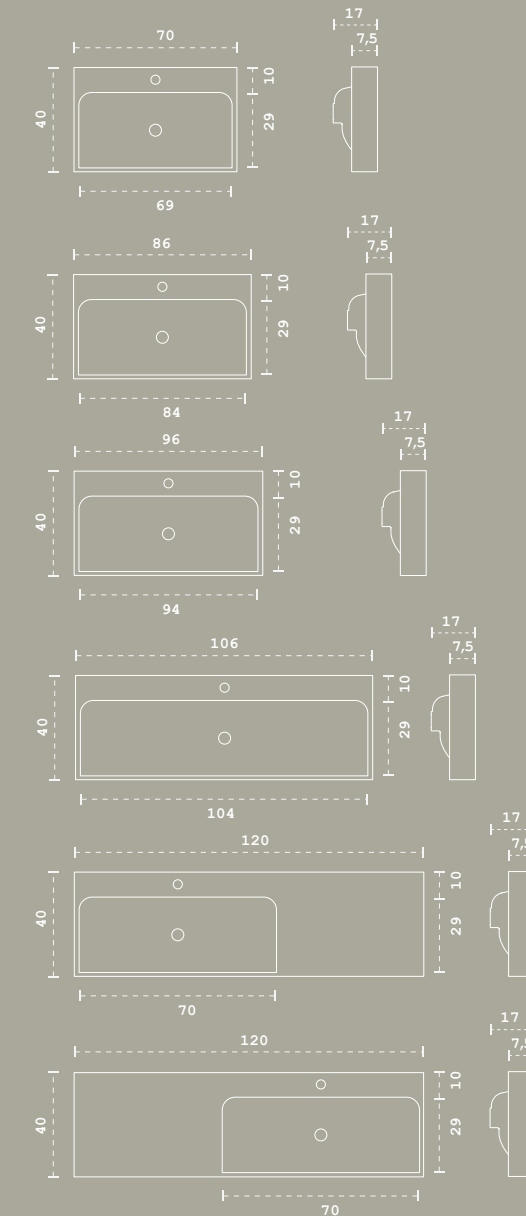

Consolle Concept p. 46,5 cm

Concept console D. 46,5 cm Plan-vasque Concept p. 46 cm.

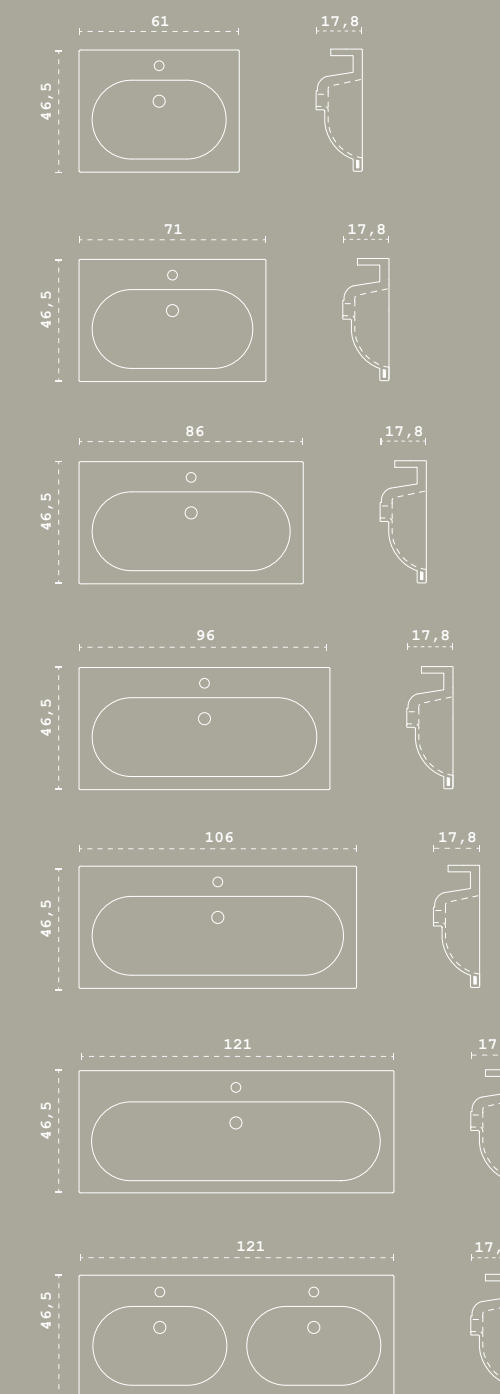

Consolle Global p. 51,5 cm

Global console D. 51,5 cm. Plan-vasque Global p. 51,5 cm.

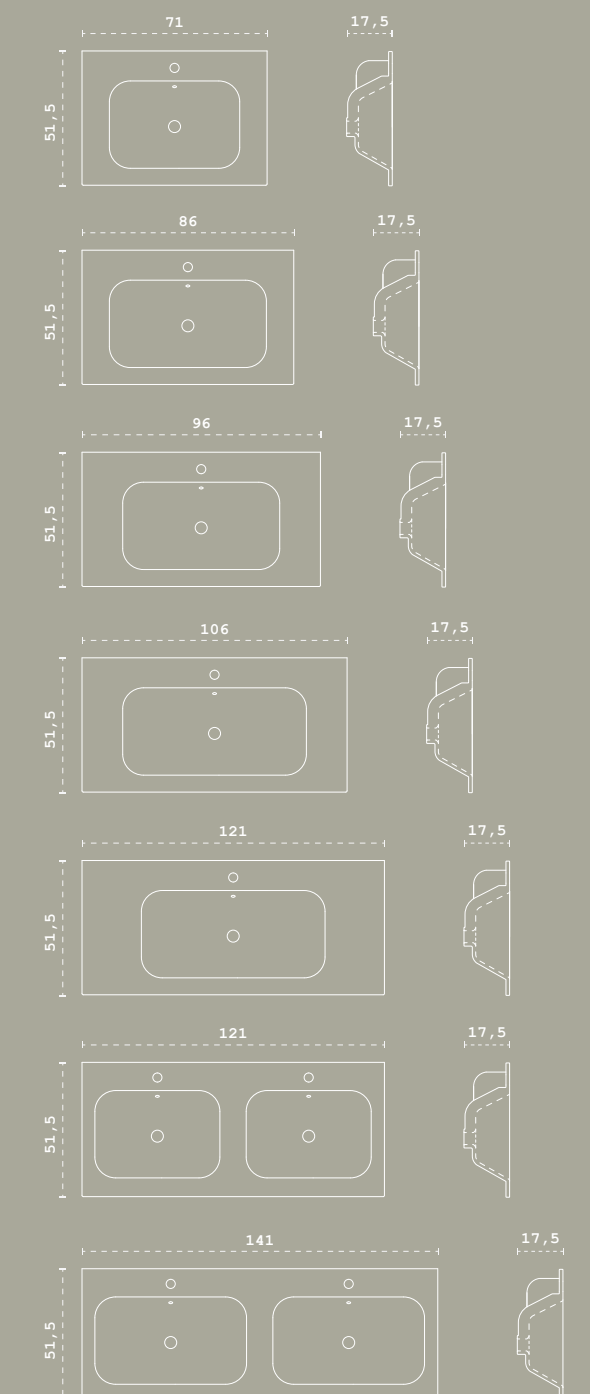

Basi curve e consolle p. 40, 46 e 51,5 cm

Curved base units and console D. 40, 46 and 51,5 cm. Éléments bas arrondis et plan-vasque p. 40, 46 et 51,5 cm.

*colore cenere opaco – lavabo monoblocco
Global
L 140 cm
matt color FO7 cenere – console Global
couleur mat FO7 cenere – plan-vasque Global*





.....

Oltre ai tradizionali elementi dritti, è possibile scegliere anche basi stondate.
Rounded base units are available as well as the traditional straight ones.
En plus que les traditionnels éléments bas droits, il est également possible de les choisir en version arrondie.



.....

I cassetti sono attrezzabili internamente con tappetini salvagoccia, separatori e vari tipi di contenitori.
The inside of the drawers can be accessorised with mats, dividers and various types of containers.
L'intérieur des tiroirs peut être aménagé avec des tapis de fond anti-gouttes, des séparations et des boîtes de rangement.



*Lo specchio contenitore ad ante,
è disponibile in varie misure e
finiture.*

*The door cabinet mirror cabinet is available in
various sizes and finishes.*

*L'armoire de toilette avec portes miroir est
disponible en différentes dimensions et finitions.*



*industrial – lavabo monoblocco Concept
L 70 cm
industrial – console Concept
industrial – plan-vasque Concept*



*colore bianco opaco effetto rovere tavolato
– lavabo Diago*

L 175 cm

mat color BNO bianco / Tavolato oak effect – Diago

standing basin

couleur mat BNO bianco / effet chêne Tavolato – vasque

à poser Diago



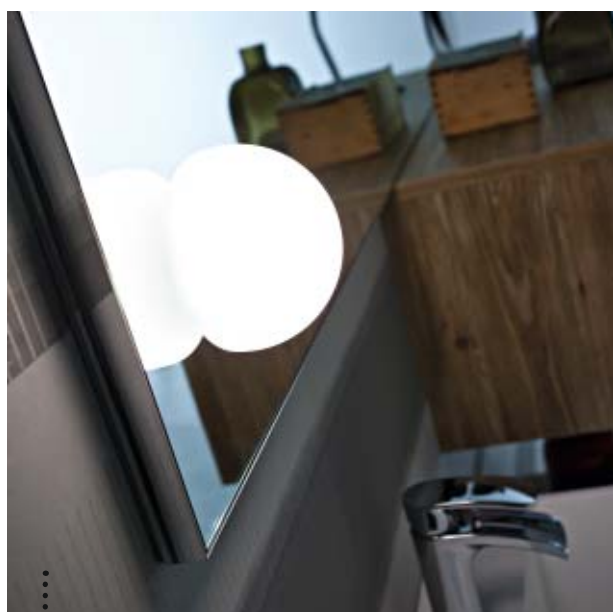

.....
Specchio con luci esterne alogene, in vetro satinato.
Mirror with external halogen lights in satin glass.
Miroir avec éclairage halogène extérieur, en verre satiné.





*industrial/colore opaco tortora – piano in
ocritec colore tortora/essenza industrial
L. 175 cm*

*industrial/colore opaco tortora – piano in ocritec colore
tortora/essenza industrial*

*industrial/colore opaco tortora – piano in ocritec colore
tortora/essenza industrial*



La barra a parete, disponibile in tutte le tinte opache, può essere attrezzata a piacimento con luci, portasciugamani, presa interruttore e diversi oggetti.

The wall-hung accessory bar is available in all matt finishes and can be fitted with lights, towel holders, sockets, switches and various other objects.

La barre murale, disponible dans toutes les finitions mates, peut être équipée, au choix, d'un éclairage, d'un porte-serviettes, d'un bloc prise-interrupteur ou d'autres accessoires encore.



*colore ghiaccio su poro aperto – piano con
vasca integrata in marmoresina bianco
opaco
L 180 cm*

*matt color FO2 ghiaccio on Paloma oak open pore –
matt white engineered marble top with integrated basin
couleur mat FO2 ghiaccio sur chêne Paloma pore ouvert
– plan de toilette avec vasque moulée en marbre de
synthèse blanc mat*





New *inclined* shapes



.....
La forma della vasca riprende il disegno della base lavabo.

The shape of the basin follows the design of the washbasin unit.

La forme de la vasque reprend le dessin du meuble sous-vasque.



*rovere corda/bianco opaco – piano con
vasca integrata in marmoresina bianco
opaco*

L 155 cm

corda oak/matt color BNO bianco – matt white

engineered marble top with integrated basin

chêne corda/couleur mat BNO bianco – plan de toilette

avec vasque moulée en marbre de synthèse blanc mat





.....

*Alternativa al piano integrato, il nuovo
lavabo in appoggio in ceramica Icon.
The new ceramic Icon standing basin is a pleasant
alternative to the top with integrated basin.
À la place du plan-vasque, on pourra choisir la vasque
à poser en céramique Icon.*



Con gli elementi di Joy, è possibile creare anche delle zone arredate con la funzione di cabina armadio.
Joy's units can even be used to create walk-in-wardrobes.
Les éléments du modèle Joy permettent également de créer et d'agencer des dressings.

Nuovi elementi e nuove soluzioni per armadiature

New units and compositions for wardrobes.
Nouveaux éléments et nouvelles solutions pour réaliser des systèmes de rangement.

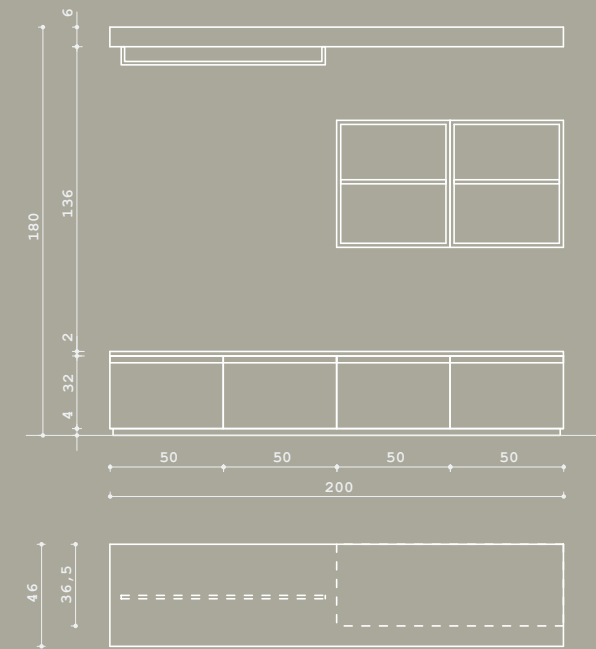
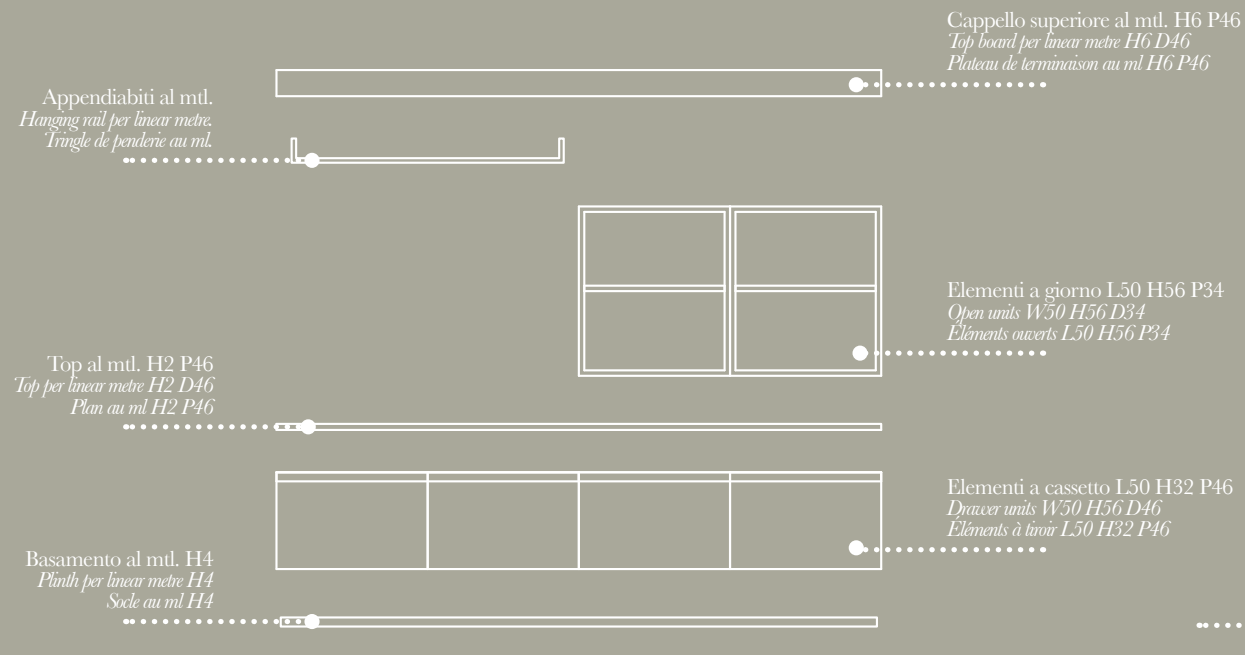

A lato, esempio di composizione esplosa, realizzata con alcuni degli elementi presenti a listino.
The side view shows a composition created using some of the elements in the price list.
Vue éclatée d'une composition réalisée avec quelques-uns des éléments présents dans le tarif.

Qui, esempio della composizione finita.
Here is an example of the finished composition.
Ici, exemple de la composition finie.

Sotto, altri esempi di composizioni finite.
Below, other examples of finished compositions.
Ci-dessous, d'autres exemples de compositions finies.

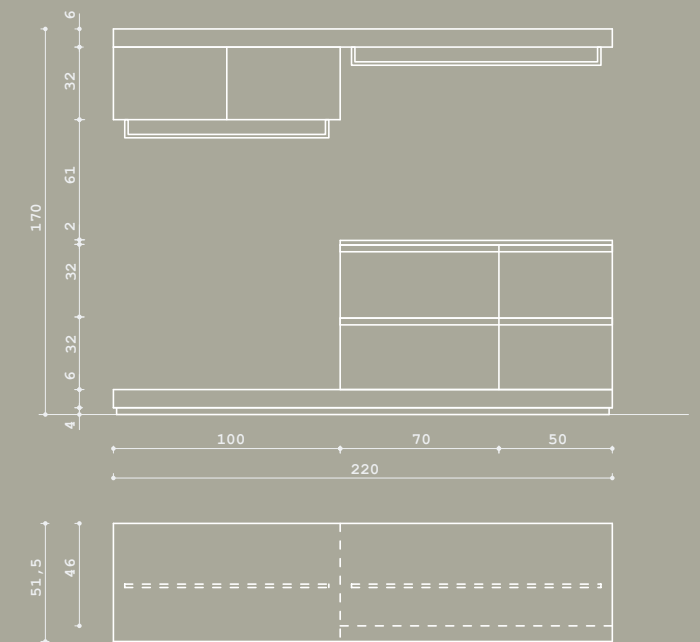
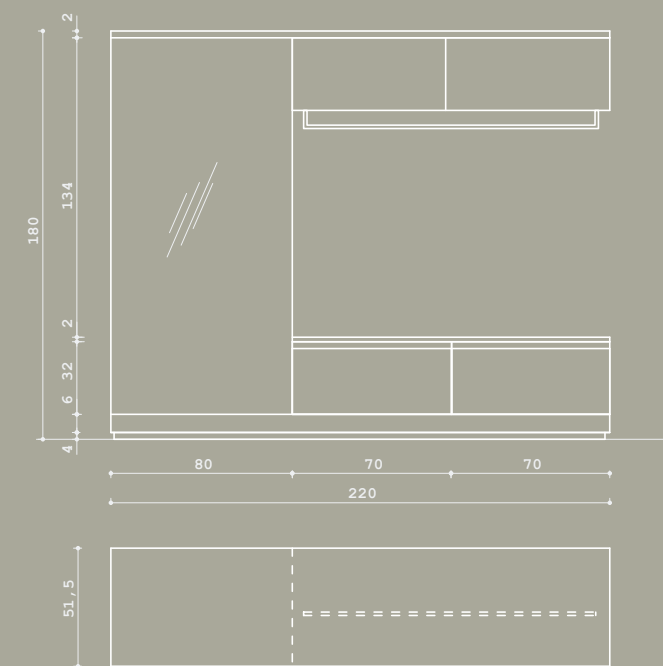
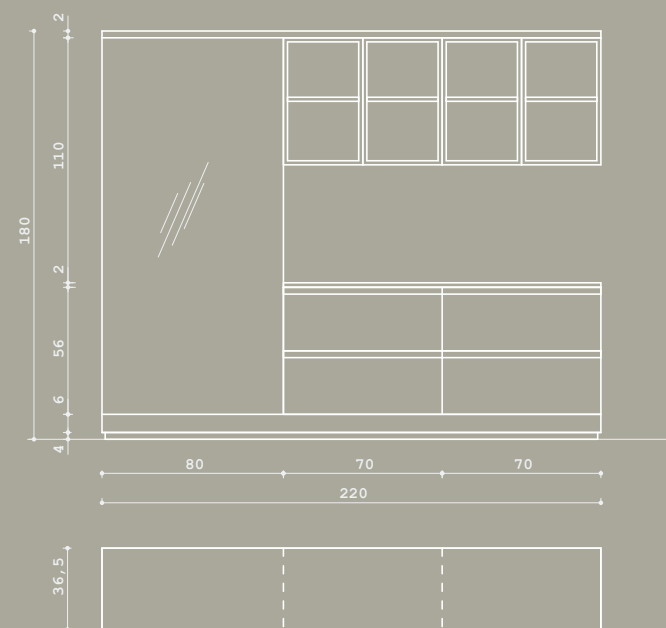
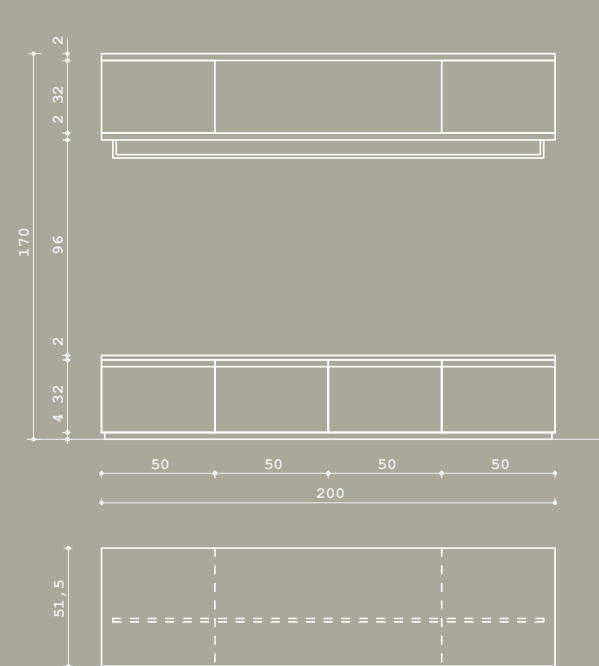



*colore ral 7006 effetto graffiato/old age –
lavabo ceramica Jazz
L 155 cm
matt color ral 7006 (scratch effect)/Old age – Jazz
standing basin
couleur mat ral 7006 (effet rugueux)/Old age – vasque
à poser Jazz*



L'elemento a giorno ad incastro, esteticamente piacevole nella finitura old age, rende la composizione molto funzionale.

As well as being very practical to use, the push-fit open elements add an aesthetically pleasant touch with their old age finish.

Esthétiquement agréable dans sa finition old age, l'élément ouvert encastrable rend la composition très fonctionnelle.

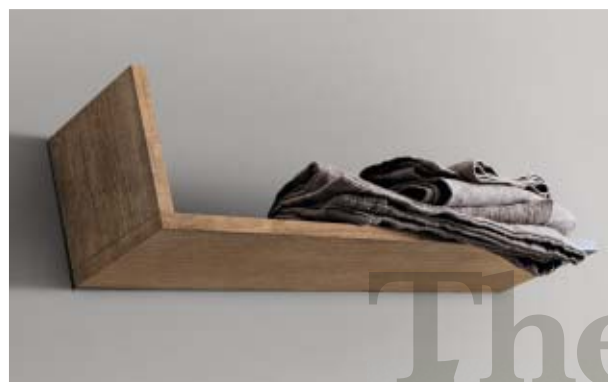

The details that make a difference



*colore nebbia su poro aperto – piano
in tecnoril bianco opaco – lavabo Kao
L 173 cm*

*matt color FO3 nebbia on Paloma oak open pore
– matt white Tecnoril top – Kao standing couleur
matt FO3 nebbia sur chêne Paloma pore ouvert –
plan de toilette en Tecnoril blanc mat – vasque à
poser Kao*



Per una maggiore resa estetica, è possibile applicare dei fianchi di finitura supplementari.

Extra end side panels can be added to the sides to make these units even more beautiful.

Pour un plus bel aspect esthétique, il est possible d'ajouter aux colonnes des joues de finition.

Extra end side panels can be added to the sides to make these units even more beautiful.



*colore opaco ral 1012 – lavabo
monoblocco Concept*

L 105 cm

matte colour ral 1012 – console Concept

couleur mat ral 1012 – plan-vasque Concept





*I tre elementi sovrapposti realizzano una nuova tipologia di colonna.
Three units installed one above the other make a new type of full height unit.
Les trois éléments superposés offrent un nouveau type de colonne.*

Shallow depths for small spaces





.....

*Colore lucido ral 6021 – lavabo
monoblocco Concept
L 95 cm
gloss color ral 6021 – console Concept
couleur brillant ral 6021 – plan-vasque Concept*



.....

Il sifone salvaspazio è sempre in dotazione in ogni base lavabo.

*The space-saving siphon is always supplied with each washbasin unit.
Le siphon gain de place est toujours fourni avec le meuble sous-vasque.*





Solo 36,5 cm di profondità per piccoli e grandi spazi

*Only 36.5-cm deep to fit in small and large spaces alike.
36,5 cm de profondeur seulement pour petits et grands espaces.*

Per ingombri ridotti di soli 36,5 cm, sono disponibili i nuovi piani in marmoresina con vasca integrale al centimetro, misura minima base lavabo 60cm.

When depths must not exceed 36.5 cm, the new engineered marble tops with integrated basins are available custom-sized to the centimetre. The minimum width of the base unit is 60cm.

Pour les profondeurs de 36,5 cm seulement, il existe de nouveaux plans de toilette en marbre de synthèse avec vasque moulée, fournis sur mesure au centimètre. Dimension minimum de l'élément sous-vasque: 60cm.



Vasche per piani prof. 36,5 in tecnoril e marmoresina
Basins for 36.5-cm deep Tecnoril and hard resin tops. Vasques pour plans prof. 36,5 en Tecnoril et marbre de synthèse.

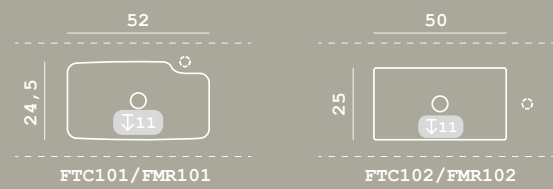

Forme per vasche integrate

*Shapes for integrated basins.
 Différentes formes pour les vasques moulées.*

Vasche per piani prof. 46 in vetro
Basins for 46-cm deep glass tops. Vasques pour plans prof. 46 en verre.

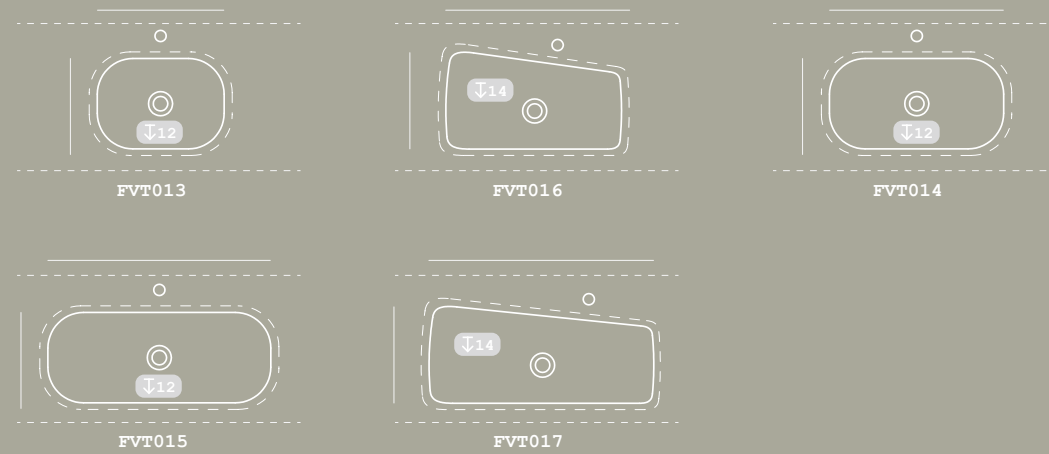

Vasche per piani prof. 51,5 in tecnoril e Deimos-stone[*]
Basins for 51.5-cm deep Tecnoril and Deimos-stone[] tops. Vasques pour plans prof. 51,5 en Tecnoril et Deimos-stone [*].*

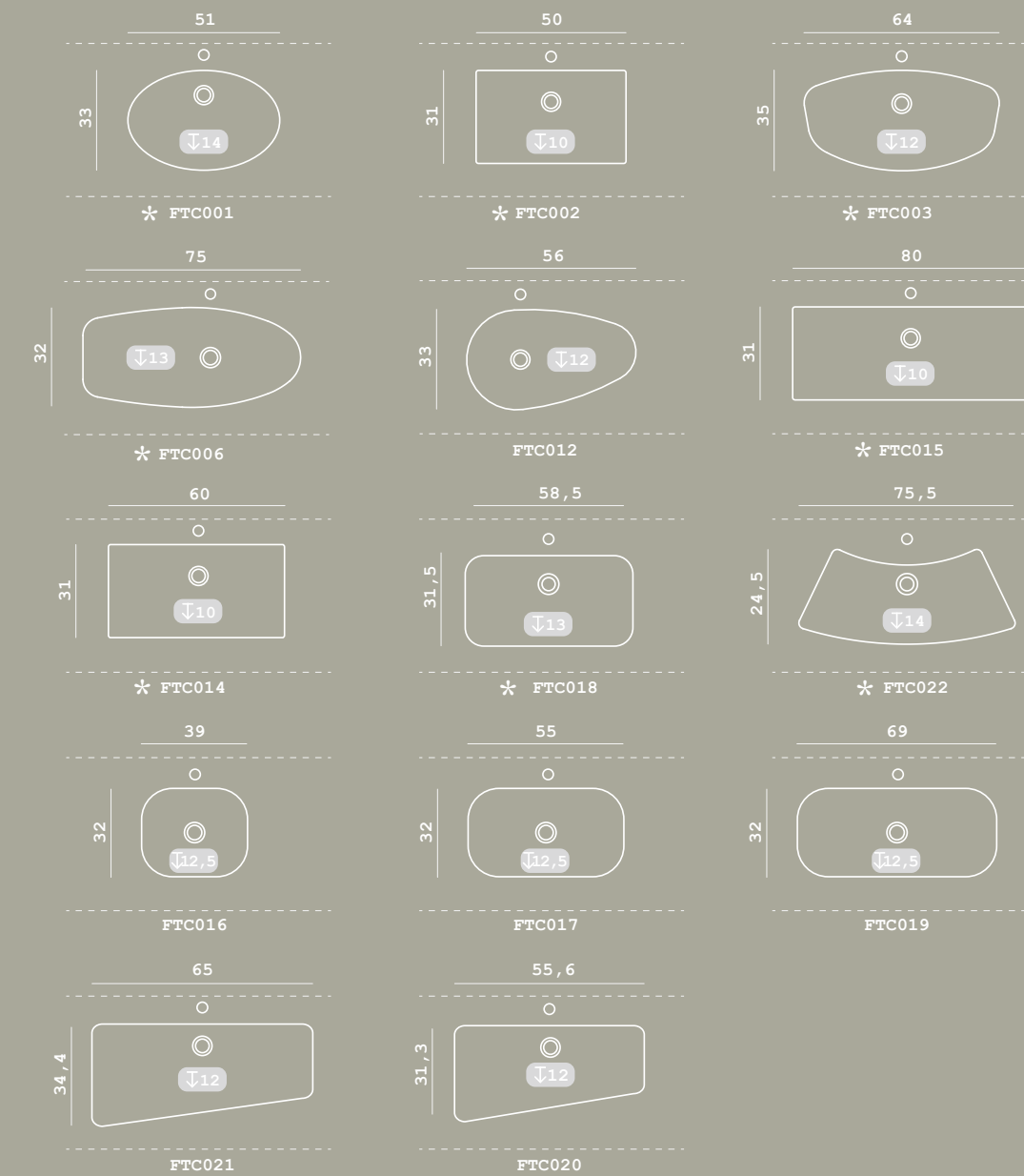

Vasche per piani prof. 46 in tecnoril e marmoresina
Basins for 46-cm deep Tecnoril and hard resin tops.

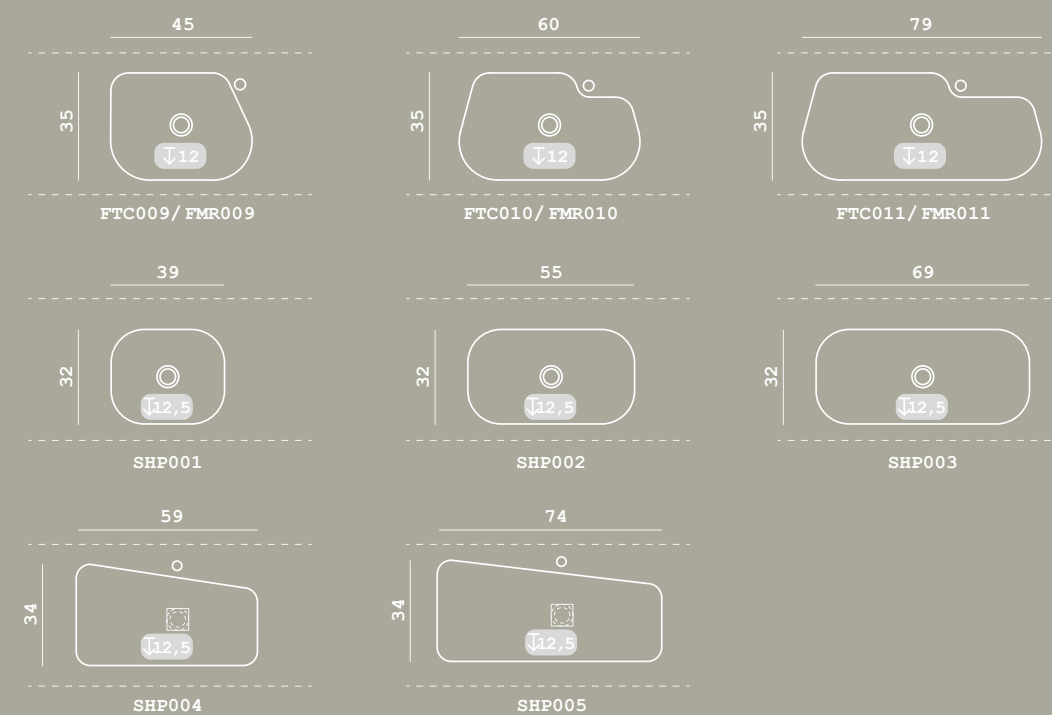

In base al materiale del piano, sono disponibili innumerevoli forme per la vasca integrata.

*Several shapes are available for integrated basins depending on the material of the top.
 En fonction du matériau choisi pour le plan de toilette, ils existent de nombreuses formes possibles pour la vasque moulée.*

*rovere papiro – lavabo Iseo
L 254cm
papiro oak – Iseo standing basin
chêne papiro – vasque à poser Iseo*



*colore opaco zucchero – piano in
marmoresina con vasca integrata
L 123 cm*

*matt colour FO1 zucchero – engineered marble top with
integrated basin*

*couleur mat FO1 zucchero – plan de toilette en marbre
de synthèse avec vasque moulée*





Divertenti ed inseribili in ogni contesto, le vetrine con telaio in alluminio sono disponibili anche nella versione a giorno.

The aluminium-framed glass full height units are fun and can be added to any setting. They are even available open fronted.

Amusantes et pouvant s'intégrer dans n'importe quel espace, les vitrines avec structure en aluminium sont également disponibles en version ouverte.

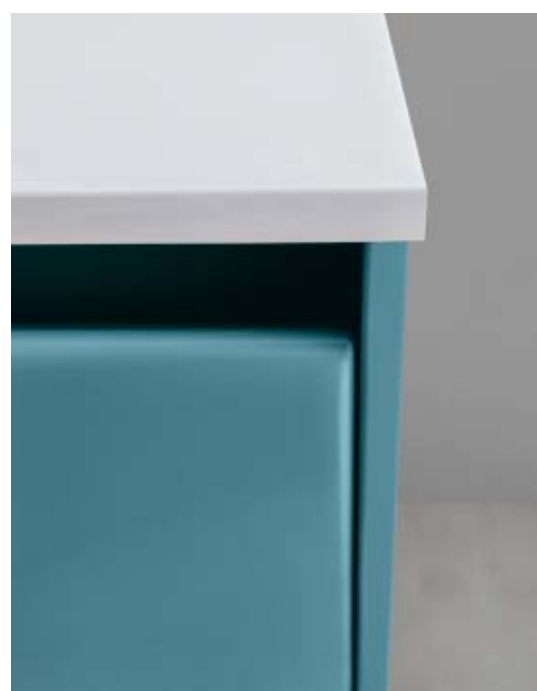

The details that make a difference



*Il mensolone con vasca integrata in ecomalta ha un'altezza di 12 cm.
 The Ecomalta top with integrated basin is 12 cm high.
 Le plan de toilette avec vasque intégrée en ecomalta a une hauteur de 12 cm.*



*rovere canapa – mensolone in ecomalta
 talco
 L 255 cm
 canapa oak – top H12 in ecomalta talco
 chêne canapa – plan de toilette H12 en ecomalta talco*



Elementi con telaio metallico

Elements with metal frames. Éléments avec cadre mètallique



Basi lavabo Washbasin units Éléments sous vasque	Colonne a giorno Full height open units Colonnes ouvertes	Boiserie Wall panelling Panneaux muraux	Sgabello Stool Tabouret	Portasciugamani Towel rail unit Porte-serviettes	Specchio con telaio Mirror with frame Miroir avec-cadre
---	--	--	--------------------------------------	---	--

Colori disponibili

Colours available. Coloris disponibles



Specchio mobile Swivel mirror Miroir pivotant	Specchio ovale Oval Mirror Miroir ovale	Bianco Bianco Bianco	Tortora Tolora Tolora	Grigio chiaro Grigio chiaro Grigio chiaro	Grigio scuro Grigio scuro Grigio scuro	Ghisa Ghisa Ghisa
--	--	-----------------------------------	------------------------------------	--	---	--------------------------------

Lampade esclusive

Exclusive light fixtures. Luminaires exclusifs



Lampada da terra Floor standing lamp Lampadaire sur pied	Lampada da soffitto Ceiling light Plafonnier	Lampada da specchio Mirror light Spot	Lampada a sospensione Pendant light Suspension
---	---	--	---

Colori disponibili

Colours available. Coloris disponibles



Bianco Bianco Bianco	Tortora Tolora Tolora	Grigio chiaro Grigio chiaro Grigio chiaro	Grigio scuro Grigio scuro Grigio scuro	Ghisa Ghisa Ghisa	Tessuto fabric tissu
-----------------------------------	------------------------------------	--	---	--------------------------------	-----------------------------------

Lavabo Martin in deimos-stone

Colori disponibili

Colours available. Coloris disponibles

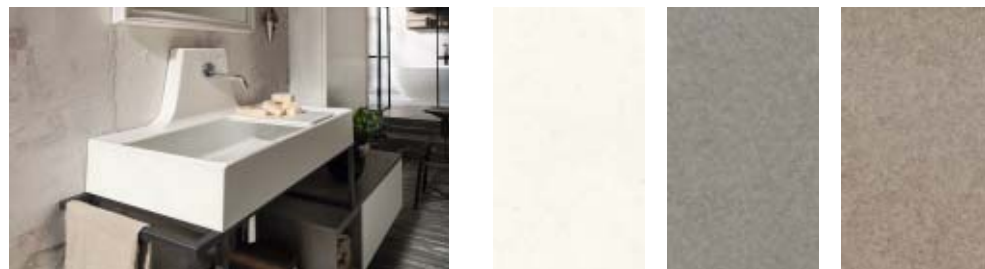

Martin laundry basin in deimos-stone Vasque Martin en deimos-stone	Bianco Sale Bianco Sale Bianco Sale	Grigio medio Grigio medio Grigio medio	Ecrù Ecrù Ecrù
--	--	---	-----------------------------

Materiale disponibile anche per piani top e mensoloni con vasca integrata.

This material is also available for slim and thick tops with integrated basins.

Matériau également disponible pour les plans de toilette et les plans H. 6-10 cm avec vasque intégrée.

Lavabo Prince in ceramica opaca

Colori disponibili

Colours available. Coloris disponibles

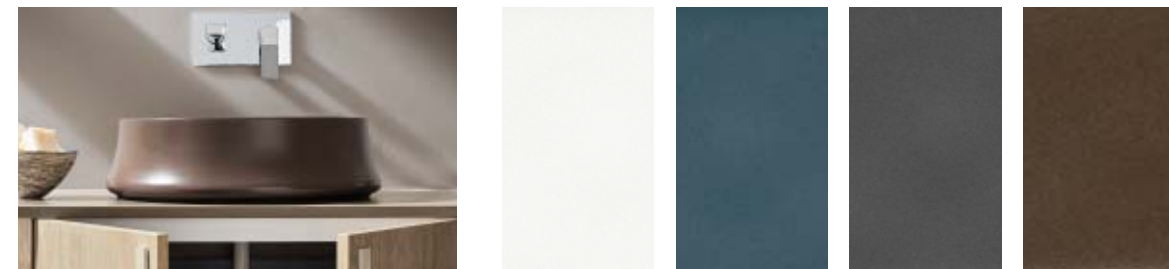

Matt ceramic Prince washbasin Vasque Prince en ceramique mate	Bianco Bianco Bianco	Avio Avio Avio	Antracite Antracite Antracite	Marrone Marrone Marrone
---	-----------------------------------	-----------------------------	--	--------------------------------------

Essenze

Wood finishes. Essences.



Rovere papiro	Natural	Rovere Canapa	Industrial	Rovere Corda	Rovere Cacao
Papiro oak	Natural	Canapa oak	Industrial	Corda oak	Cacao oak
Chêne papiro	Natural	Chêne canapa	Industrial	Chêne corda	Chêne cacao

Finiture naturali *Natural finishes Finitions naturelles*

Disponibili solo per top, mensole, mensoloni e vani a giorno. Available for slim tops, shelves, thick tops and open compartments only. Disponibles uniquement pour plans et plans h.6/10cm, étagères et éléments ouverts.



Effetto Pietra	Effetto Cemento	Effetto Rovere	Old age	Oxyde Dark	Oxyde Rust
Pietra effect	Cemento effect	Tavolato oak effect	Old age	Oxyde Dark	Oxyde Rust
Effet pierre	Effet cemento	Effet chêne tavolato	Old age	Oxyde Dark	Oxyde Rust

Finiture ecomalta per top e mensoloni

Ecomalta finishes for slim and thick tops. Finitions ecomalta pour plans et plans h.6/10 cm.

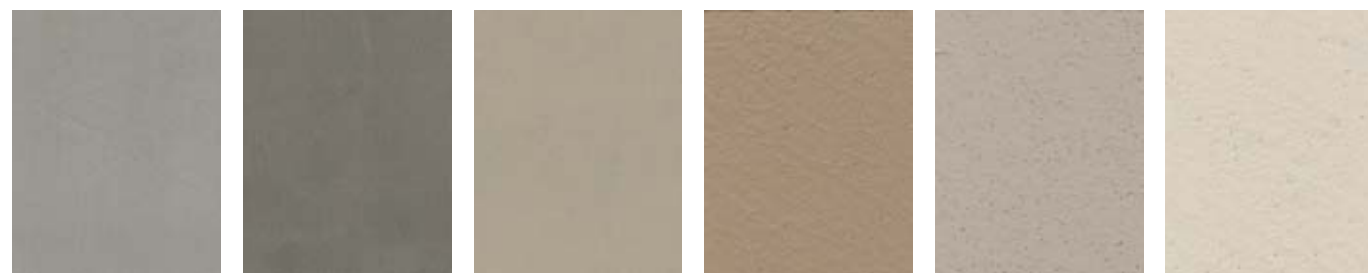

Nebbia	Fango	Beige	Argilla	Sand	Talco
Nebbia	Fango	Beige	Argilla	Sand	Talco
Nebbia	Fango	Beige	Argilla	Sand	Talco

Ocritec

Ocritec colours. Coloris Ocritec

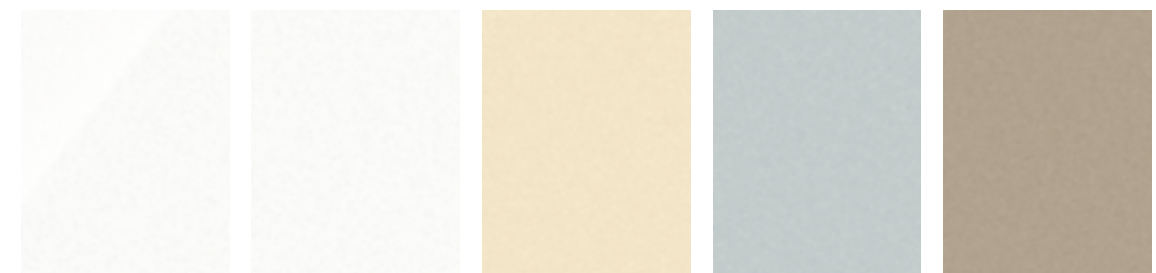

Bianco lucido	Bianco opaco	Vaniglia opaco	Fog opaco	Tortora opaco
Gloss Bianco	Matt Bianco	(ral 1015)	(ral 7035)	(ral 1019)
Blanc brillant	Blanc mat	Matt Vaniglia	Matt Fog	Matt Tortora
		Vaniglia mat	Fog mat	Tortora mat

Pietre naturali *Natural stone Pierres naturelles*

Disponibili per top e mensoloni con vasche costruite. Ecomalta finishes for slim and thick tops. Disponibles pour plans et plans h.10/h.6 avec vasques collées et intégrées.



Emperador Dark	Maron Marinace	Lillak	Quarz white	Quarz grigio scuro	Tatum cloudy beige
Emperador Dark	Maron Marinace	Lillak	Quarz white	Quarz grigio scuro	Tatum cloudy beige
Emperador Dark	Maron Marinace	Lillak	Quarz white	Quarz grigio scuro	Tatum cloudy beige



Tatum brughiera	Tatum portland grey
Tatum brughiera	Tatum portland grey
Tatum brughiera	Tatum portland grey

Abbinamenti essenze /Ocritec colorato opaco

Wood /Matt coloured Ocritec pairings. Combinaisons essences /Ocritec coloré mat

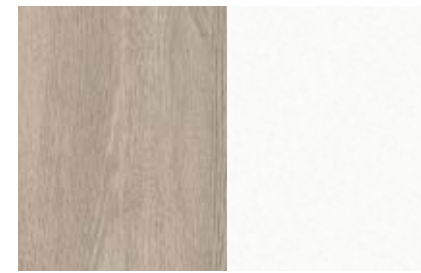
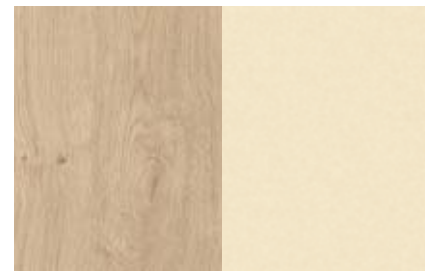
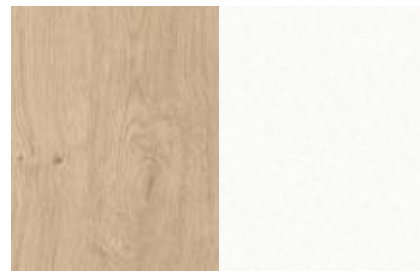

Materials.	Natural	Bianco Opaco	Natural	Vaniglia Opaco	Rovere Canapa	Bianco Opaco	Rovere Canapa	Tortora Opaco	Industrial	Tortora Opaco
Materials.	Natural	Matt Bianco	Natural	Matt Vaniglia	Canapa oak	Matt Bianco	Canapa oak	Matt Tortora	Industrial	Matt Tortora
Matériaux.	Natural	Blanc mat	Natural	Vaniglia mat	Chêne canapa	Blanc mat	Chêne canapa	Tortora mat	Industrial	Tortora mat

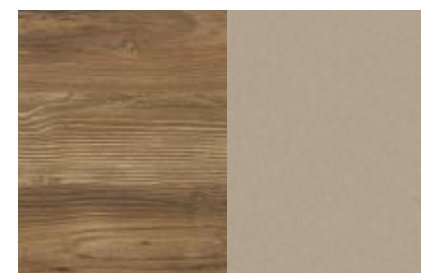
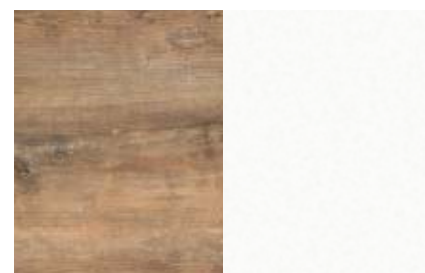
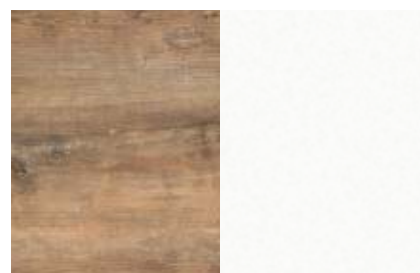

Old age	Bianco Opaco	Old age	Bianco Opaco	Effetto rovere	Tortora Opaco	Effetto Cemento	Bianco Opaco	Effetto Cemento	Fog opaco
Old Age	Matt Bianco	Old Age	Matt Bianco	Tavolato oak effect	Matt Tortora	Cemento effect	Matt Bianco	Cemento effect	Matt Fog
Old Age	Blanc mat	Old Age	Blanc mat	Effet chêne tavolato	Tortora mat	Effet cemento	Blanc mat	Effet cemento	Fog mat

Finiture disponibili nei colori laccati a campione

Finishes available for our palette laquer colours. Finitions disponibles dans les coloris laqués sur échantillon



Liscio opaco	Liscio lucido	Poro aperto opaco	Graffiato opaco
Plain matt	Plain gloss	Matt open pore	Matt Graffiato
Lisse mat	Lisse brillant	pores ouverts mat	Graffiato mat

Elementi per fianco cassetti

Elements to attach to drawer side panels. Accessoires à fixer au côté du tiroir.

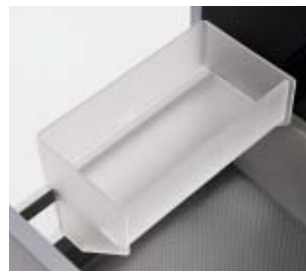

Scatola 1 vano

Box with 1 compartment
Boîte 1 compartiment

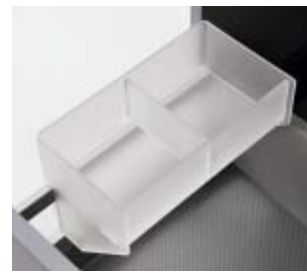

Scatola 2 vano

Box with 2 compartments
Boîte 2 compartiments



Porta bicchiere

Glas holder
Boîte avec porte-verre



Porta kleenex

Tissue box holder
Boîte porte-kleenex

Elementi appoggio

Standing elements. Accessoires à poser. Aufsatzelemente. Elementos de apoyo.



Pattumiera

Garbage box
Boîte poubelle



Scatola 1 vano

Box with 1 compartment
Boîte 1 compartiment



Scatola 3 vani

Box with 3 compartments
Boîte 3 compartiments



Scatola porta kleenex

Tissue box holder
Boîte porte-kleenex



Scatola 1 vano piccolo con portatrucchi

Box with 1 small compartment and vanity section
Boîte 1 petit compartiment et range-maquillage



Scatola 1 vano grande con portatrucchi

Box with 1 large compartment with vanity section
Boîte 1 grand compartiment range-maquillage



Porta phon

Hair dryer holder
Boîte pour sèche-cheveux



Scatola 1 vano grande con portatrucchi

Box with 1 large compartment with vanity section
Boîte 1 grand compartiment range-maquillage

Elementi di servizio

Miscellaneous accessories. Éclairage et séparateurs. Nützliches Zubehör. Elementos auxiliares.



Separatori

Dividers
Séparateurs



Luce interna cassetto

Interior light for drawers
Éclairage intérieur tiroir



Tappettino

Mat
Tapis fond de tiroir

Elementi per interno pensili

Elements to fit inside door panels. Accessoires pour intérieur portes.



Luce interno pensile

Interior light for wall unit
Éclairage intérieur élément haut



Scatola con coperchio

Box with lid
Boîte avec couvercle



Porta calamita

Magnet for accessories
Aimant pour accessoires



Porta bicchiere

Glas holder
Porte-verre

Barra attrezzata

Wall-hung accessory bar. Barre murale équipée.



Barra attrezzata in alluminio con luce led e presa interruttore, colore opaco a campione

Aluminium wall-hung bar with led light, socket and switch, available in matt colours
Barre équipée en aluminium avec éclairage à leds et prise/interrupteur, coloris mat



Porta asciugamano cromato a misura, per barra attrezzata

Custom-sized, chromed towel holder for wall-hung accessory bar
Porte-serviettes chromé sur mesure, pour barre équipée



Scatola con coperchio piccola

Small Box with lid
Petite boîte avec couvercle



Scatola con coperchio grande

Large Box with lid
Grande boîte avec couvercle



Porta bicchiere

Glas holder
Porte-verre



Porta sapone

Glas holder
Porte-savon



Porta phon

Hair dryer holder
Porte sèche-cheveux



Porta calamita

Magnet for accessories
Aimant pour accessoires



Specchio ingranditore

Magnifying mirror
Miroir grossissant

Accessori

Accessories. Accessoires.



Luce fondo mobile

Bottom panel light
Éclairage sous meuble



attrezzatura in lamiera

Sheet metal accessories
Accessoires intérieurs en tôle



portascarpe

Shoe rack
Range-chaussures



Cestone estraibile

Pullout basket
Panier coulissant



Sacca biancheria

Laundry basket
Sac à linge intérieur



Sifone salvaspazio

Space-saver trap
Siphon gain de place

AD: **ID_Alzo**
Foto: **Photografica**
Stylist: **Cristina Chinellato**
Fotolito: **GmStudio 1**
Stampa: **Grafiche Peruzzo**

Si ringrazia: **Twils - Veneta Cuscini, Pinton, Fdv - Leucos, Eumenes**

Cerasa

Cerasa Spa Via Borgo Nobili, 19 - 31010 Bibano di Godega di Sant'Urbano (TV) Italy Tel +39 0438 - 783411 Fax +39 0438 783450 www.cerasa.it - info@cerasa.it